

SINGLE CAVITY SLIDER - SQUARE SET (L/H) TYPE G30

FOR GLASS DOOR

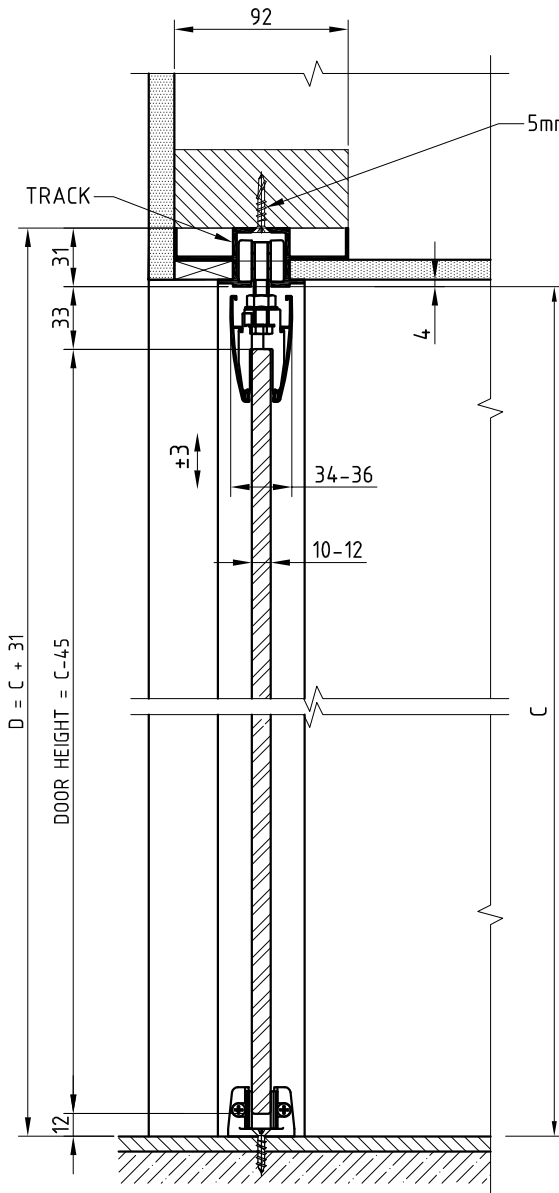

SECTION A - A

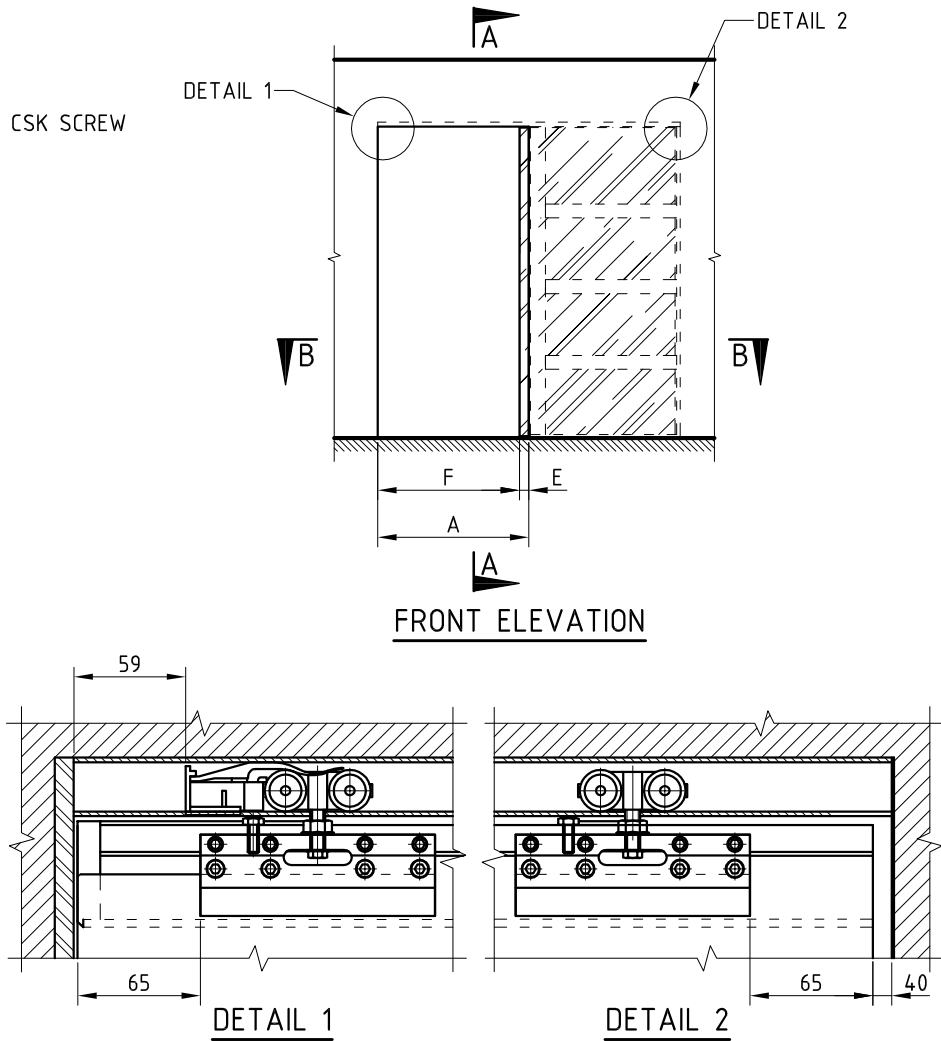

FRONT ELEVATION

DETAIL 1

DETAIL 2

- A - OPENING FRAME WIDTH.
- B - OVERALL FRAME SIZE.
- C - DISTANCE FROM FINISHED FLOOR TO UNDERSIDE OF TRACK.
- D - DISTANCE FROM FINISHED FLOOR TO UNDERSIDE OF SUPPORT BEAM.
- E - PROJECTION OF DOOR FROM CAVITY.
- F - CLEAR OPENING WIDTH.

NOTES:

1. MAX. DOOR THICKNESS 10-12mm.
2. MAX. DOOR WEIGHT - 100kg.
3. END JAMB - BY OTHERS.
4. SUITS 10-13mm PLASTER BOARD.

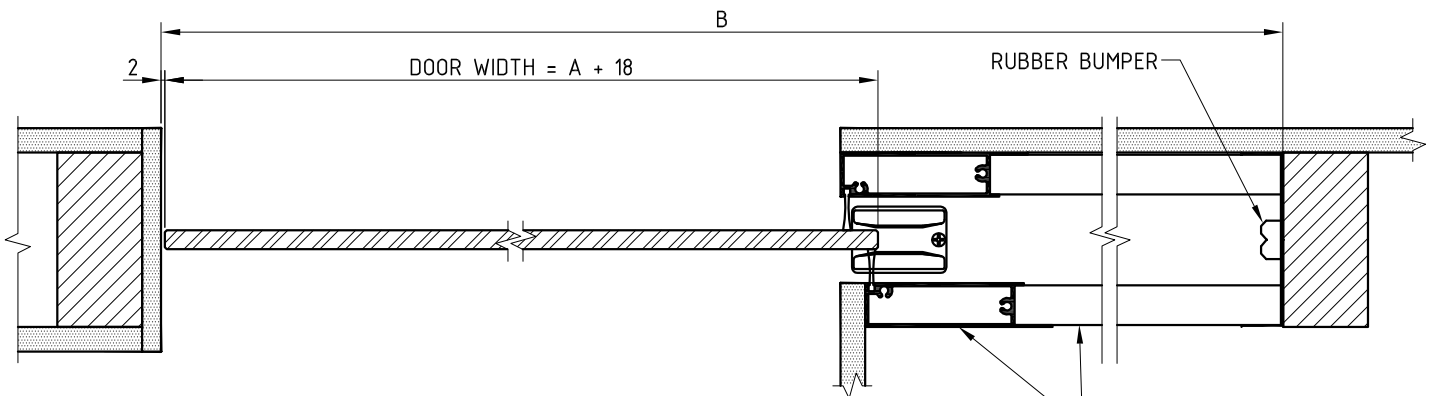

SECTION B - B